



WM02DN095C

Dual N-Channel Enhancement Mode MOSFET

Description

WM02DN095C uses advanced power trench technology that has been especially tailored to minimize the on-state resistance. This device is suitable for un-directional or bidirectional load switch, facilitated by its common-drain configuration.

$V_{(BR)DSS}(V)$	$I_D(A)$	$R_{DS(on)TYP}(m\Omega)$
20	9.5	7.4 @ $V_{GS}=4.5V$
		7.8 @ $V_{GS}=4.0V$
		8.0 @ $V_{GS}=3.7V$
		8.8 @ $V_{GS}=3.1V$
		10.4 @ $V_{GS}=2.5V$

Features

- Super high dense cell for low $R_{DS(ON)}$
- RoHS Compliant and Halogen-Free
- ESD protected: Class 2

Applications

- Battery protection
- Load switch

Schematic & PIN Configuration

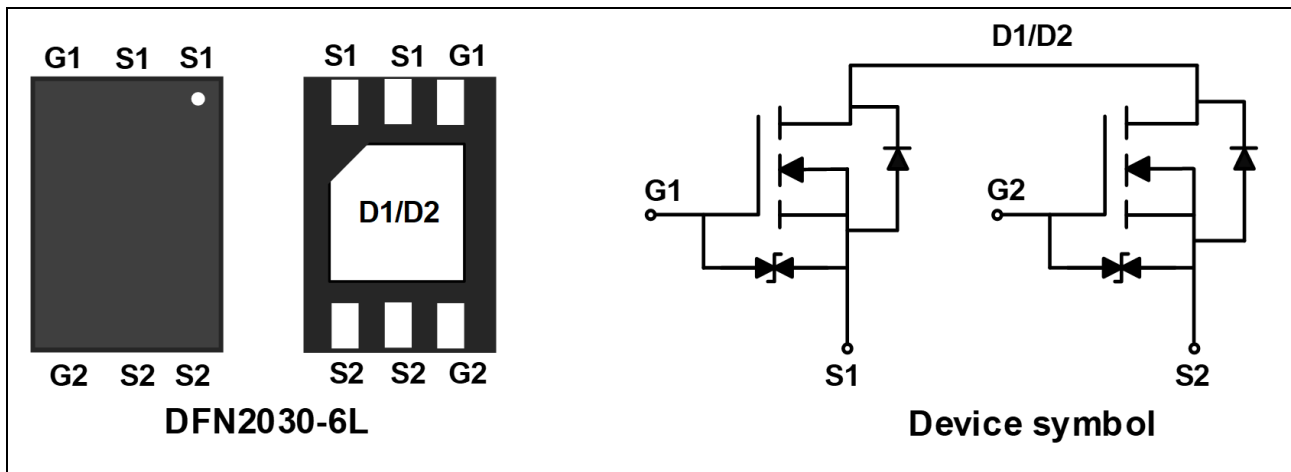

Absolute Maximum Rating

Parameter	Symbol	Value	Unit
Drain-Source voltage	V_{DS}	20	V
Gate-Source voltage	V_{GS}	± 12	V
Continuous Drain Current	I_D	$T_A=25^\circ C$	9.5
		$T_A=70^\circ C$	7.6
Pulsed Drain Current ¹	I_{DM}	60	A
Single Pulse Avalanche Energy ⁵	EAS	31	mJ
Avalanche Current	I_{AS}	25	A
Total Power Dissipation	P_D	1.56	W
Operating Junction and Storage Temperature Range	T_J, T_{STG}	-55 to +150	$^\circ C$
Maximum Junction-to-Ambient ²	$R_{\theta JA}$	80	$^\circ C/W$

Electrical Characteristics ($T_{amb}=25^{\circ}\text{C}$ unless otherwise noted)

Parameter	Symbol	Test Conditions	Min.	Typ.	Max.	Unit
Static Characteristics						
Drain-Source Breakdown Voltage	$V_{(BR)DSS}$	$V_{GS} = 0V, I_D = 250\mu A$	20	-	-	V
Gate-body Leakage Current	I_{GSS}	$V_{DS} = 0V, V_{GS} = \pm 8V$	-	-	± 10	μA
Zero Gate Voltage Drain Current	I_{DSS}	$V_{DS} = 20V, V_{GS} = 0V$	-	-	1	μA
Gate-Threshold Voltage ³	$V_{GS(th)}$	$V_{DS} = V_{GS}, I_D = 250\mu A$	0.45	-	1.5	V
Drain-Source on-Resistance ³	$R_{DS(on)}$	$V_{GS} = 4.5V, I_D = 5A$	5.4	7.4	9.4	m Ω
		$V_{GS} = 4.0V, I_D = 5A$	5.8	7.8	9.8	
		$V_{GS} = 3.7V, I_D = 5A$	6	8	10	
		$V_{GS} = 3.1V, I_D = 5A$	6.4	8.8	11.2	
		$V_{GS} = 2.5V, I_D = 5A$	8	10.4	12.8	
Forward Transconductance ³	g_{fs}	$V_{DS} = 5V, I_D = 5A$	-	42	-	S
Dynamic Characteristics						
Input Capacitance	C_{iss}	$V_{DS} = 10V, V_{GS} = 0V, f = 1MHz$	-	1647	-	pF
Output Capacitance	C_{oss}		-	170	-	
Reverse Transfer Capacitance	C_{rss}		-	148	-	
Switching Characteristics						
Total Gate Charge ⁴	Q_g	$V_{GS} = 4.5V, V_{DS} = 15V, I_D = 5.5A$	-	22	-	nC
Gate-Source Charge ⁴	Q_{gs}		-	3.1	-	
Gate-Drain Charge ⁴	Q_{gd}		-	8.2	-	
Turn-on Delay Time ⁴	$t_{d(on)}$	$V_{GS} = 4.5V, V_{DD} = 15V, R_G = 6\Omega, I_D = 5.5A$	-	10	-	nS
Rise Time ⁴	t_r		-	39.5	-	
Turn-off Delay Time ⁴	$t_{d(off)}$		-	65	-	
Fall Time ⁴	t_f		-	30	-	
Drain-Source Body Diode Characteristics						
Diode Forward Voltage	V_{SD}	$I_S = 9.5A, V_{GS} = 0V$	-	-	1.2	V

Notes:

1. Repetitive Rating: Pulse width limited by maximum junction temperature.
2. Surface mounted on FR4 board using 1 square inch pad size, 1oz single-side copper.
3. Pulse Test: Pulse width $\leq 300\mu s$, duty cycle $\leq 2\%$.
4. Guaranteed by design, not subject to product
5. The EAS data shows Max. rating . The test condition is $V_{DD}=25V, V_{GS}=10V, L=0.1mH, I_{AS}=25A$.

Typical Characteristics

Figure 1. Output Characteristics

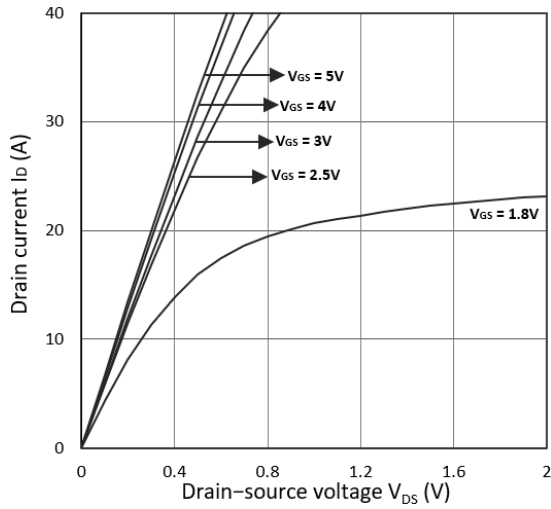

Figure 2. Transfer Characteristics

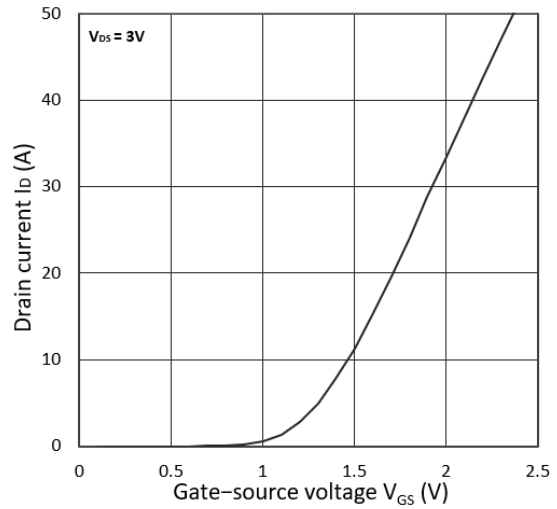

Figure 3. $R_{DS(ON)}$ vs. I_D

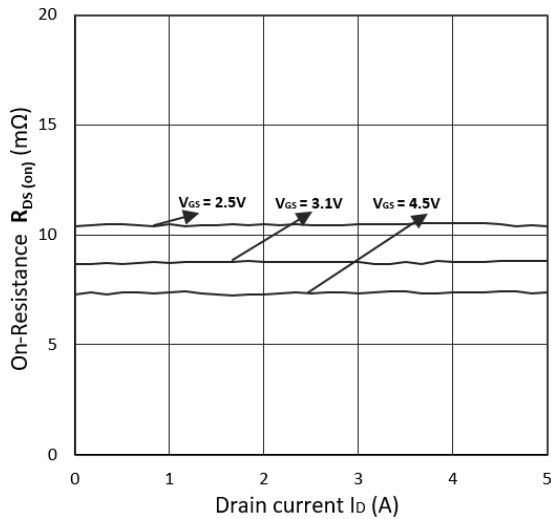

Figure 4. $R_{DS(ON)}$ vs. V_{GS}

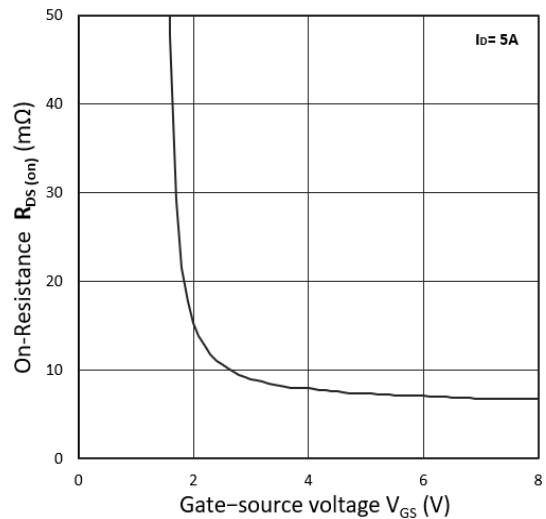

Figure 5. I_S vs. V_{SD}

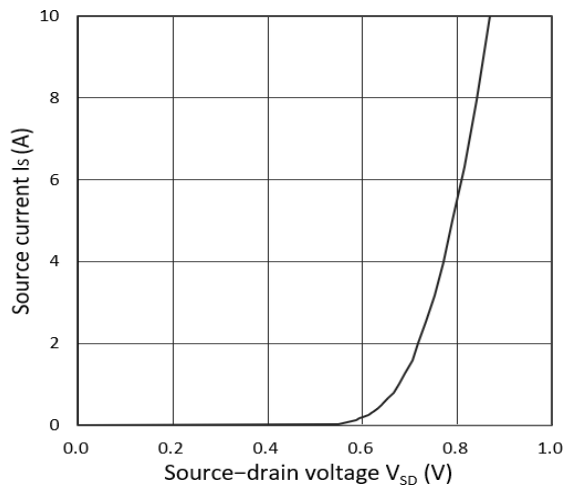
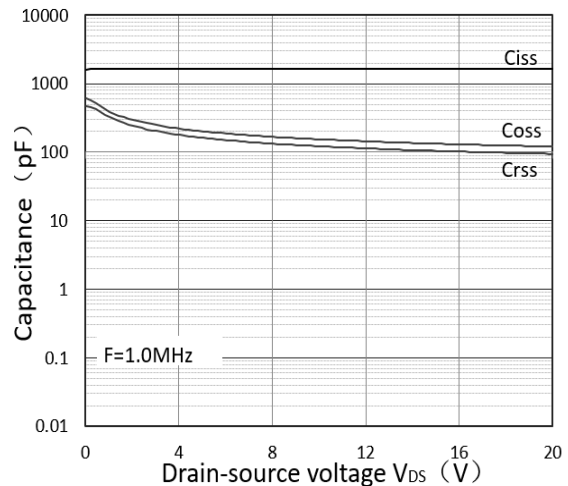

Figure 6. Capacitance Characteristics



Outline Drawing –DFN2030-6L

PACKAGE OUTLINE

TOP VIEW

BOTTOM VIEW

SIDE VIEW

DFN2030-6L

DIMENSIONS

SYMBOL	MILLIMETER		INCHES	
	MIN	MAX	MIN	MAX
A	0.70	0.80	0.028	0.031
A1	0.00	0.05	0.000	0.002
A2	0.203		0.008	
D	1.95	2.05	0.077	0.081
E	2.95	3.05	0.116	0.120
k	1.65	1.75	0.057	0.061
D1	1.45	1.55	0.065	0.069
b	0.20	0.30	0.008	0.012
e	0.50 BSC		0.020BSC	
L	0.30	0.40	0.012	0.016

Marking Codes

Part Number	WM02DN095C
Marking Code	<div style="border: 1px solid black; padding: 5px; display: inline-block;"> </div> <p>C095N02 = Device Code WWXX XXX= Date Code</p>

Package Information

Qty: 3k/Reel

CONTACT INFORMATION

No.1001, Shiwan (7) Road, Pudong District, Shanghai, P.R.China.201207

Tel: 86-21-68969993 Fax: 86-21-50757680 Email: market@way-on.com

WAYON website: <http://www.way-on.com>

For additional information, please contact your local Sales Representative.

WAYON® is registered trademark of Wayon Corporation.

Specifications are subject to change without notice.
The device characteristics and parameters in this data sheet can and do vary in different applications and actual device performance may vary over time.
Users should verify actual device performance in their specific applications.